







20 004 715

- diamètre de percement 32 mm
- rosace 60 x 47 mm
- avec marquage chaud



S'adapte aux gammes suivantes : CL.1, CYO

| | | |
|---|-----------------------------|---------------|
|  | Platine brossé | 20 004 715-06 |
|  | Chrome | 20 004 715-00 |
|  | Laiton brossé (Or 23cts) | 20 004 715-28 |
|  | Champagne brossé (Or 22cts) | 20 004 715-46 |
|  | Champagne (Or 22cts) | 20 004 715-47 |
|  | Dark Platinum brossé | 20 004 715-99 |

20 004 715

mm [inches]



Diagramme de débit



Certificats

IAPMO_4976 (5). IAPMO_N-4976. LGA_28687. IAPMO_6397.

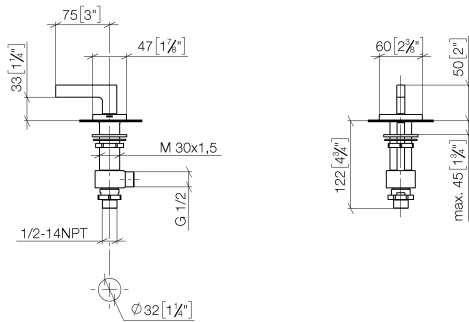
20 004 715

Les pièces pour les autres finitions peuvent être trouvées ici : Chrome

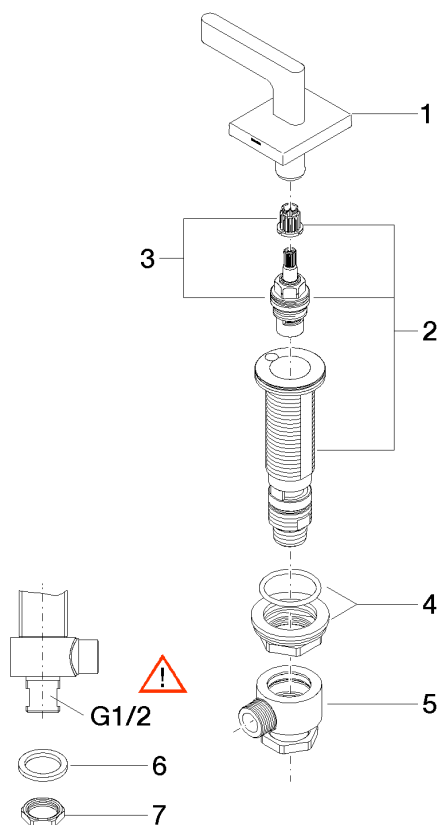

Liste des pièces de rechange

| N° | Article Numéro | Désignation | Fréquence de montage | Délai de livraison |
|----|--------------------|------------------|----------------------|--------------------|
| 1 | 90 20 70 057 02-06 | poignée (hot) | 1 | 10 |
| 2 | 04 17 11 058 53 90 | partie latérale | 1 | 2 |
| 3 | 90 90 03 153 00 90 | tête céramique | 1 | 2 |
| 4 | 04 23 10 032 78 90 | set de fixation | 1 | 2 |
| 5 | 04 17 11 023 10 90 | raccord multiple | 1 | 2 |
| 6 | 09 30 11 059 90 | rondelle | 1 | 2 |
| 7 | 09 23 10 012 90 | écrou | 1 | 2 |